

New Products

September 2024
G CLEF ACOUSTIC LTD

WELLFLOAT®

WELLFLOAT Pegasus II

4-layer "multi-stage pendulum" high-end audio rack



This world's first 4-layer "multi-stage pendulum" high-end audio rack incorporating all the technologies of WELLFLOAT Babel, which became an unprecedented worldwide hit as a top-quality audio insulator, and WELLFLOAT Double, which has been captivating many audio enthusiasts since its release in October last year.

About WELLFLOAT

WELLFLOAT is an outstanding vibration suppression mechanism that utilises the same principle as a gravitational wave detector. Its patented 'multi-stage pendulum' structure allows it to effectively control vibrations down to the molecular level, making it significantly more effective than other audio insulators offered by different brands.

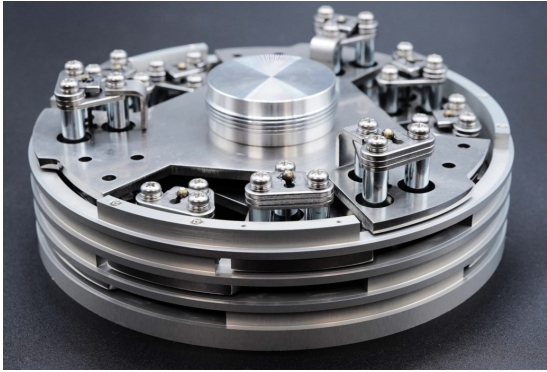

Internal structure of WELLFLOAT Babel
4-layer multi-stage pendulum

The series has become quite popular 14 years after its initial release, offering a wide range of products from audio boards to insulators for musical instruments. Notably, the "WELLFLOAT Babel" released in 2022 and the "Double 4548" released in the autumn of last year have been huge hits, thanks to their outstanding sound quality improvements and sophisticated designs.

Features : 4-layer "multi-stage pendulum" high-end audio rack

■ Multi-stage pendulum rack shelf section

The rack shelf's three bottom plates are made of rugged stainless steel, which ensures high rigidity and a low center of gravity.

This shelf section alone can be used as a two-tiered multi-stage pendulum audio rack.



Mr. Shiro Nakamura, a world-famous car designer who produced numerous masterpieces such as GT-R and Fairlady Z at Nissan Motors. He designed a new generation of WELLFLOAT.

■ Multi-stage pendulum audio board "Double 4548"

Two-stage pendulum base frame structure and Double4548, a four-stage pendulum effect equivalent to Babel is achieved.



** You can also use your own audio board.*

WELLFLOAT / Double 4548

Specification

- Design : 4-layer "multi-stage pendulum" structure comprising 2 layers of rack shelves and 2 layers of Double 4548 boards
- Material : Stainless steel (shelf), aluminum (pole)
- Dimensions : 635 x 501mm (floor installation size)
- Load capacity : 95kg/static load per shelf
(When using Double4548, equipment weight up to 85kg)

Main dimensions

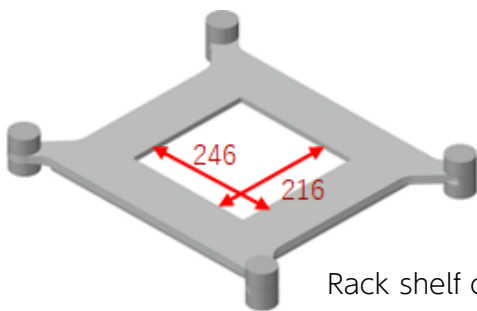

Rack shelf opening dimensions

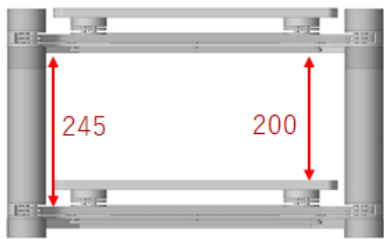

When using Upper Shelf L200

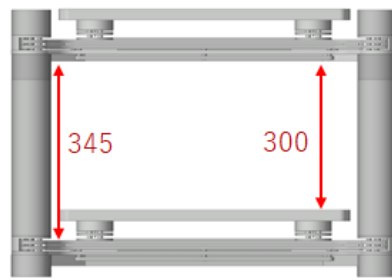

When using Upper Shelf L300

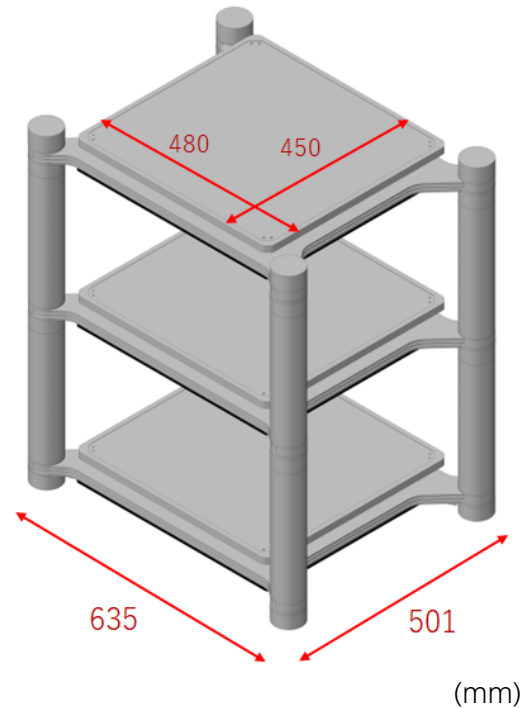

(mm)

About Black finish

- The rack section has a black painted finish.
- For the Double4548-BK, only the outer aluminum frame has a black anodized finish. The stainless steel top plate and mechanism are the same silver color as the previous model.

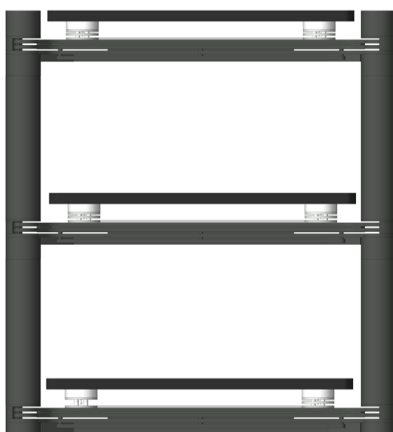

Composition

Rack shelf section

NO.	Model Name	Silver	Black	Weight	What's in the box
①	Pegasus II Bottom Shelf	-SV	-BK	18kg	End Caps x4
②	Pegasus II Upper Shelf L200	-SV	-BK	21kg	Poles (shelf spacing 200mm) x4
③	Pegasus II Upper Shelf L300	-SV	-BK	22kg	Poles (shelf spacing 300mm) x4

Audio Board Section

④	Double 4548	(Current model)	-BK	11kg	-
---	-------------	-----------------	-----	------	---

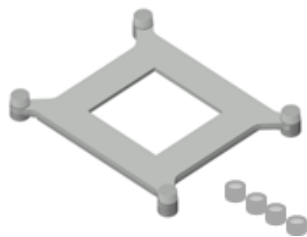

①Bottom Shelf

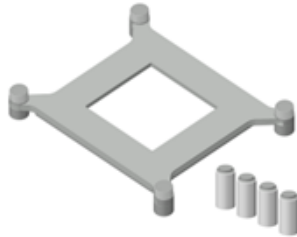

②Upper Shelf L200

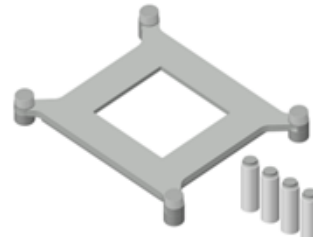

③Upper Shelf L300

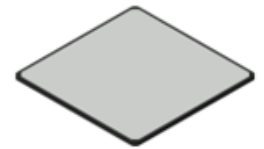

④Double 4548

Combination example (when using Double 4548 on the board)

